

Inspiron 15

5000 Series

Service Manual

Computer Model: Inspiron 15–5551
Regulatory Model: P51F
Regulatory Type: P51F003



Notes, cautions, and warnings



NOTE: A NOTE indicates important information that helps you make better use of your computer.



CAUTION: A CAUTION indicates either potential damage to hardware or loss of data and tells you how to avoid the problem.



WARNING: A WARNING indicates a potential for property damage, personal injury, or death.

Copyright © 2015 Dell Inc. All rights reserved. This product is protected by U.S. and international copyright and intellectual property laws. Dell™ and the Dell logo are trademarks of Dell Inc. in the United States and/or other jurisdictions. All other marks and names mentioned herein may be trademarks of their respective companies.

2015 - 03

Rev. A00

Contents

Before working inside your computer.....	10
Before you begin	10
Safety instructions.....	10
Recommended tools.....	11
After working inside your computer.....	13
Removing the battery.....	14
Procedure.....	14
Replacing the battery.....	15
Procedure.....	15
Removing the optical drive.....	16
Prerequisites.....	16
Procedure.....	16
Replacing the optical drive.....	19
Procedure.....	19
Post-requisites.....	19
Removing the base cover.....	20
Prerequisites.....	20
Procedure.....	20
Replacing the base cover.....	21
Procedure.....	21
Post-requisites.....	21

Removing the memory modules.....	22
Prerequisites.....	22
Procedure.....	22
Replacing the memory modules.....	24
Procedure.....	24
Post-requisites.....	25
Removing the hard drive.....	26
Prerequisites.....	26
Procedure.....	26
Replacing the hard drive.....	30
Procedure.....	30
Post-requisites.....	30
Removing the wireless card.....	31
Prerequisites.....	31
Procedure.....	31
Replacing the wireless card.....	33
Procedure.....	33
Post-requisites.....	33
Removing the coin-cell battery.....	34
Prerequisites.....	34
Procedure.....	34
Replacing the coin-cell battery.....	36
Procedure.....	36
Post-requisites.....	36

Removing the keyboard.....	37
Prerequisites.....	37
Procedure.....	37
Replacing the keyboard.....	40
Procedure.....	40
Post-requisites.....	40
Removing the computer base.....	41
Prerequisites.....	41
Procedure.....	41
Replacing the computer base.....	46
Procedure.....	46
Post-requisites.....	46
Removing the optical-drive interposer.....	47
Prerequisites.....	47
Procedure.....	47
Replacing the optical-drive interposer.....	49
Procedure.....	49
Post-requisites.....	49
Removing the speakers.....	50
Prerequisites.....	50
Procedure.....	50
Replacing the speakers.....	52
Procedure.....	52
Post-requisites.....	52

Removing the I/O board.....	53
Prerequisites.....	53
Procedure.....	53
Replacing the I/O board.....	55
Procedure.....	55
Post-requisites.....	55
Removing the heat-sink assembly.....	56
Prerequisites.....	56
Procedure.....	56
Replacing the heat-sink assembly.....	58
Procedure.....	58
Post-requisites.....	58
Removing the power-button module.....	60
Prerequisites.....	60
Procedure.....	60
Replacing the power-button module.....	63
Procedure.....	63
Post-requisites.....	63
Removing the system board.....	64
Prerequisites.....	64
Procedure.....	64
Replacing the system board.....	69
Procedure.....	69
Post-requisites.....	69

Removing the display assembly.....	71
Prerequisites.....	71
Procedure.....	71
Replacing the display assembly.....	74
Procedure.....	74
Post-requisites.....	74
Removing the display bezel.....	75
Prerequisites.....	75
Procedure.....	75
Replacing the display bezel.....	77
Procedure.....	77
Post-requisites.....	77
Removing the display panel.....	78
Prerequisites.....	78
Procedure.....	78
Replacing the display panel.....	81
Procedure.....	81
Post-requisites.....	81
Removing the display hinges.....	82
Prerequisites.....	82
Procedure.....	82
Replacing the display hinges.....	84
Procedure.....	84
Post-requisites.....	84

Removing the display cable.....	85
Prerequisites.....	85
Procedure.....	85
Replacing the display cable.....	87
Procedure.....	87
Post-requisites.....	87
Removing the display back-cover and antenna assembly.....	88
Prerequisites.....	88
Procedure.....	88
Replacing the display back-cover and antenna assembly.....	90
Procedure.....	90
Post-requisites.....	90
Removing the camera.....	91
Prerequisites.....	91
Procedure.....	91
Replacing the camera.....	93
Procedure.....	93
Post-requisites.....	93
Removing the power-adapter port.....	94
Prerequisites.....	94
Procedure.....	94
Replacing the power-adapter port.....	96
Procedure.....	96
Post-requisites.....	96



Removing the palm-rest assembly.....	97
Prerequisites.....	97
Procedure.....	97
Replacing the palm-rest assembly.....	99
Procedure.....	99
Post-requisites.....	99
Flashing the BIOS.....	100

Before working inside your computer

 **CAUTION:** To avoid damaging the components and cards, handle them by their edges and avoid touching pins and contacts.









 **NOTE:** The images in this document may differ from your computer depending on the configuration you ordered.

Before you begin

- 1 Save and close all open files and exit all open applications.
 - 2 Shut down your computer.
 - Windows 8.1: On the **Start** screen, click or tap the power icon  → **Shut down**.
 - Windows 7: Click or tap **Start** → **Shut down**.
-  **NOTE:** If you are using a different operating system, see the documentation of your operating system for shut-down instructions.
- 3 Disconnect your computer and all attached devices from their electrical outlets.
 - 4 Disconnect all cables such as telephone cables, network cables and so on, from your computer.
 - 5 Disconnect all attached devices and peripherals, such as keyboard, mouse, monitor, and so on, from your computer.
 - 6 Remove any media card and optical disc from your computer, if applicable.
 - 7 After the computer is unplugged, press and hold the power button for 5 seconds to ground the system board.

Safety instructions

Use the following safety guidelines to protect your computer from potential damage and ensure your personal safety.

-  **WARNING:** Before working inside your computer, read the safety information that shipped with your computer. For more safety best practices, see the Regulatory Compliance home page at dell.com/regulatory_compliance.
-  **WARNING:** Disconnect all power sources before opening the computer cover or panels. After you finish working inside the computer, replace all covers, panels, and screws before connecting to the power source.
-  **CAUTION:** To avoid damaging the computer, ensure that the work surface is flat and clean.
-  **CAUTION:** To avoid damaging the components and cards, handle them by their edges and avoid touching pins and contacts.
-  **CAUTION:** You should only perform troubleshooting and repairs as authorized or directed by the Dell technical assistance team. Damage due to servicing that is not authorized by Dell is not covered by your warranty. See the safety instructions that shipped with the product or at dell.com/regulatory_compliance.
-  **CAUTION:** Before touching anything inside your computer, ground yourself by touching an unpainted metal surface, such as the metal at the back of the computer. While you work, periodically touch an unpainted metal surface to dissipate static electricity, which could harm internal components.
-  **CAUTION:** When you disconnect a cable, pull on its connector or on its pull tab, not on the cable itself. Some cables have connectors with locking tabs or thumb-screws that you must disengage before disconnecting the cable. When disconnecting cables, keep them evenly aligned to avoid bending any connector pins. When connecting cables, ensure that the ports and connectors are correctly oriented and aligned.
-  **CAUTION:** To disconnect a network cable, first unplug the cable from your computer and then unplug the cable from the network device.
-  **CAUTION:** Press and eject any installed card from the media-card reader.

Recommended tools

The procedures in this document may require the following tools:

- Philips screwdriver
- Plastic scribe

After working inside your computer



CAUTION: Leaving stray or loose screws inside your computer may severely damage your computer.

- 1 Replace all screws and ensure that no stray screws remain inside your computer.
- 2 Connect any external devices, peripherals, and cables you removed before working on your computer.
- 3 Replace any media cards, discs, and any other parts that you removed before working on your computer.
- 4 Connect your computer and all attached devices to their electrical outlets.
- 5 Turn on your computer.

Removing the battery

⚠ WARNING: Before working inside your computer, read the safety information that shipped with your computer and follow the steps in [Before working inside your computer](#). After working inside your computer, follow the instructions in [After working inside your computer](#). For more safety best practices, see the Regulatory Compliance home page at dell.com/regulatory_compliance.

Procedure

- 1 Close the display and turn the computer over.
- 2 Slide the battery latch to the unlocked position.
- 3 Using your fingertips, lift the battery at an angle and remove the battery off the computer base.

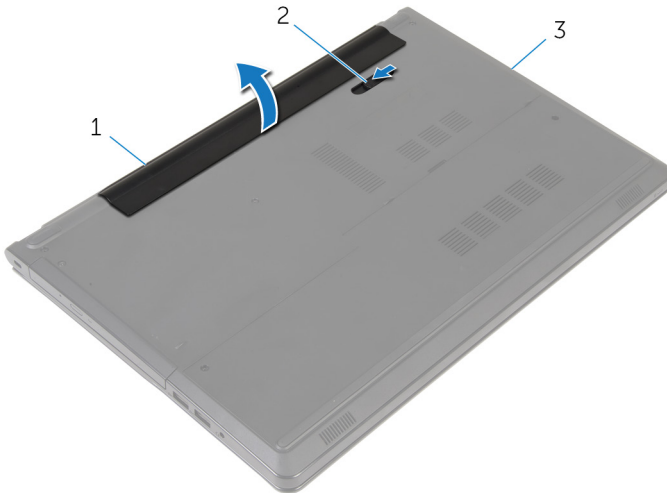

1 battery

2 battery latch

3 computer base

- 4 Turn the computer over, open the display, and press the power button for five seconds to ground the computer.

Replacing the battery



WARNING: Before working inside your computer, read the safety information that shipped with your computer and follow the steps in [Before working inside your computer](#). After working inside your computer, follow the instructions in [After working inside your computer](#). For more safety best practices, see the Regulatory Compliance home page at dell.com/regulatory_compliance.

Procedure

Slide the tabs on the battery into the slots on the battery bay and snap the battery into place.

Removing the optical drive



WARNING: Before working inside your computer, read the safety information that shipped with your computer and follow the steps in [Before working inside your computer](#). After working inside your computer, follow the instructions in [After working inside your computer](#). For more safety best practices, see the Regulatory Compliance home page at dell.com/regulatory_compliance.

Prerequisites

Remove the [battery](#).

Procedure

- 1 Remove the screw that secures the optical-drive assembly to the computer base.
- 2 Using a plastic scribe, push the optical drive through the slot to release the optical-drive assembly out of the optical-drive bay.

3 Slide the optical-drive assembly out of the optical-drive bay.

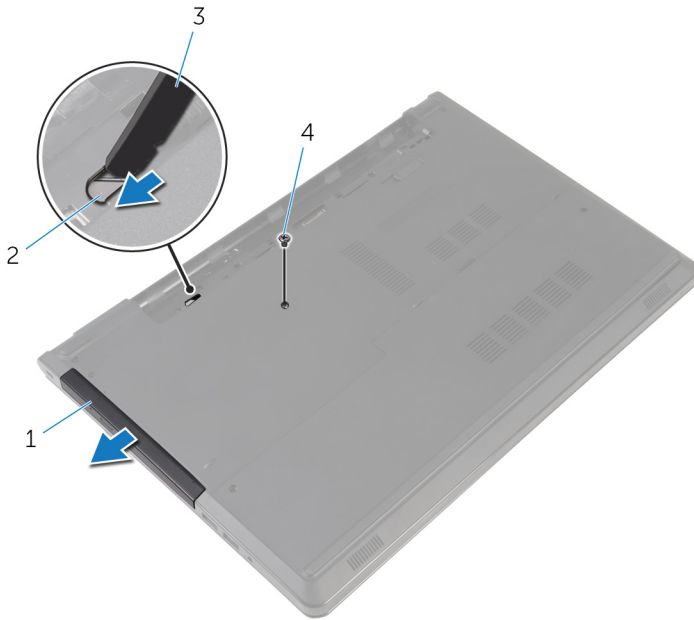

1 optical-drive assembly

2 optical-drive slot

3 plastic scribe

4 screw

4 Carefully pull the optical-drive bezel and remove it from the optical drive.

- 5 Remove the screws that secure the optical-drive bracket to the optical drive and remove the optical-drive bracket.

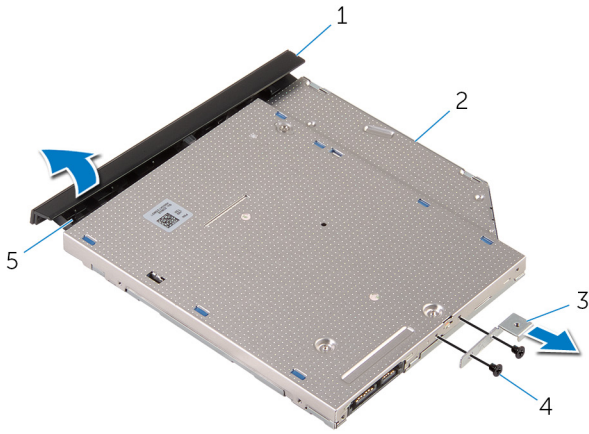

- | | | | |
|---|-----------------------|---|---------------|
| 1 | optical-drive bezel | 2 | optical drive |
| 3 | optical-drive bracket | 4 | screws (2) |
| 5 | tab | | |

Replacing the optical drive



WARNING: Before working inside your computer, read the safety information that shipped with your computer and follow the steps in [Before working inside your computer](#). After working inside your computer, follow the instructions in [After working inside your computer](#). For more safety best practices, see the Regulatory Compliance home page at dell.com/regulatory_compliance.

Procedure

- 1 Align the screw holes on the optical-drive bracket with the screw holes on the optical drive.
- 2 Replace the screws that secure the optical-drive bracket to the optical drive.
- 3 Align the tabs on the optical-drive bezel with the slots on the optical drive and snap the optical-drive bezel into place.
- 4 Slide the optical-drive assembly into the optical-drive bay and align the screw hole on the optical-drive bracket with the screw hole on the computer base.
- 5 Replace the screw that secures the optical-drive assembly to the computer base.

Post-requisites

Replace the [battery](#).

Removing the base cover

⚠ WARNING: Before working inside your computer, read the safety information that shipped with your computer and follow the steps in [Before working inside your computer](#). After working inside your computer, follow the instructions in [After working inside your computer](#). For more safety best practices, see the Regulatory Compliance home page at dell.com/regulatory_compliance.

Prerequisites

Remove the [battery](#).

Procedure

- 1 Close the display and turn the computer over.
- 2 Remove the screws that secure the base cover to the computer base.
- 3 Using your fingertips, pry the base cover starting at the top edge out of the computer base.
- 4 Lift the base cover off the computer base.

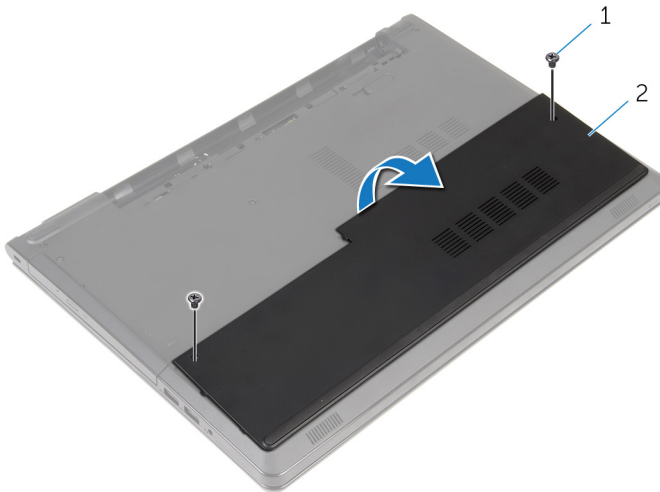

1 screws (2)

2 base cover

Replacing the base cover



WARNING: Before working inside your computer, read the safety information that shipped with your computer and follow the steps in [Before working inside your computer](#). After working inside your computer, follow the instructions in [After working inside your computer](#). For more safety best practices, see the Regulatory Compliance home page at dell.com/regulatory_compliance.

Procedure

- 1 Slide the base cover into the computer base and snap the base cover into place.
- 2 Replace the screws that secure the base cover to the computer base.

Post-requisites

Replace the [battery](#).

Removing the memory modules

 **WARNING:** Before working inside your computer, read the safety information that shipped with your computer and follow the steps in [Before working inside your computer](#). After working inside your computer, follow the instructions in [After working inside your computer](#). For more safety best practices, see the Regulatory Compliance home page at dell.com/regulatory_compliance.

Prerequisites

- 1 Remove the [battery](#).
- 2 Remove the [base cover](#).

Procedure

 **NOTE:** The number of memory modules may be different on your computer depending on the configuration you ordered.

- 1 Use your fingertips to carefully spread apart the securing clips on each end of the memory-module slot until the memory module pops up.

2 Remove the memory module from the memory-module slot.

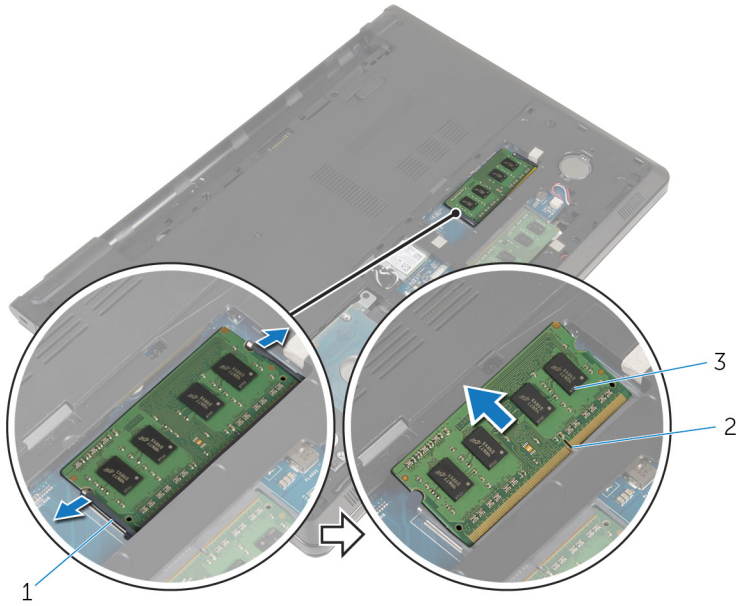

- 1 securing clips (2)
- 3 memory module

2 memory-module slot

Replacing the memory modules

 **WARNING:** Before working inside your computer, read the safety information that shipped with your computer and follow the steps in [Before working inside your computer](#). After working inside your computer, follow the instructions in [After working inside your computer](#). For more safety best practices, see the Regulatory Compliance home page at dell.com/regulatory_compliance.

Procedure

- 1 Align the notch on the memory module with the tab on the memory-module slot.

- Slide the memory module firmly into the slot at an angle and press the memory module down until it clicks into place.

 **NOTE:** If you do not hear the click, remove the memory module and reinstall it.

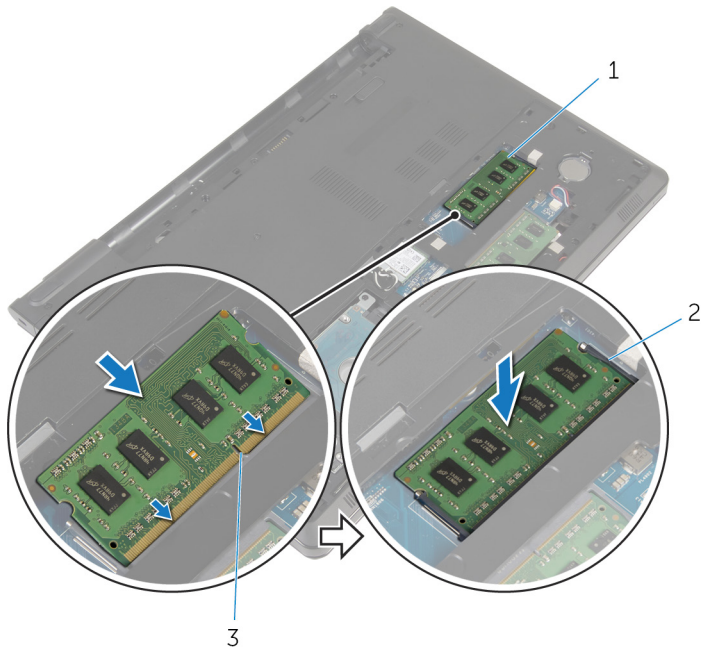



- memory module
- memory-module slot

- securing clips (2)

Post-requisites

- Replace the [base cover](#).
- Replace the [battery](#).

Removing the hard drive

-  **WARNING:** Before working inside your computer, read the safety information that shipped with your computer and follow the steps in [Before working inside your computer](#). After working inside your computer, follow the instructions in [After working inside your computer](#). For more safety best practices, see the Regulatory Compliance home page at dell.com/regulatory_compliance.
-  **CAUTION:** Hard drives are fragile. Exercise care when handling the hard drive.
-  **CAUTION:** To avoid data loss, do not remove the hard drive while the computer is in sleep or on state.

Prerequisites

- 1 Remove the [battery](#).
- 2 Remove the [base cover](#).

Procedure

- 1 Lift the latch and using the pull tab disconnect the hard-drive cable from the system board.
- 2 Remove the screws that secure the hard-drive assembly to the computer base.

- 3** Lift the hard-drive assembly out of the computer base using the hard-drive pull tab.

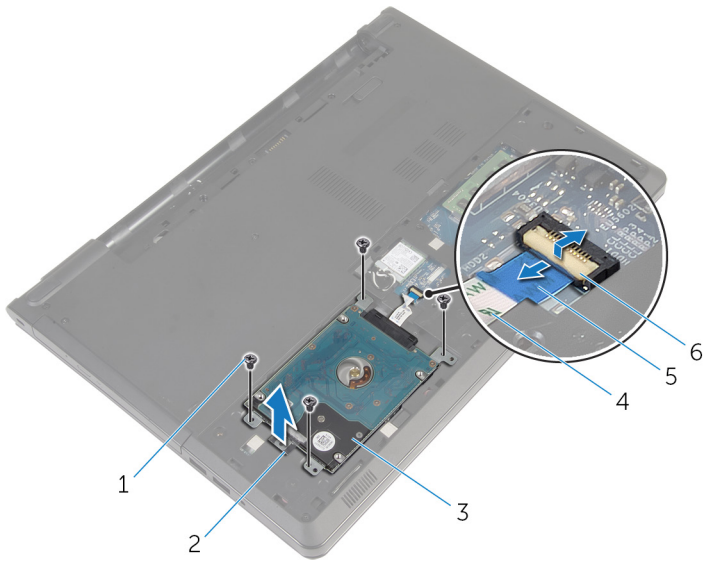

- | | | | |
|---|---------------------|---|---------------------|
| 1 | screws (4) | 2 | hard-drive pull tab |
| 3 | hard-drive assembly | 4 | hard-drive cable |
| 5 | pull tab | 6 | latch |

- 4 Disconnect the interposer from the hard drive.

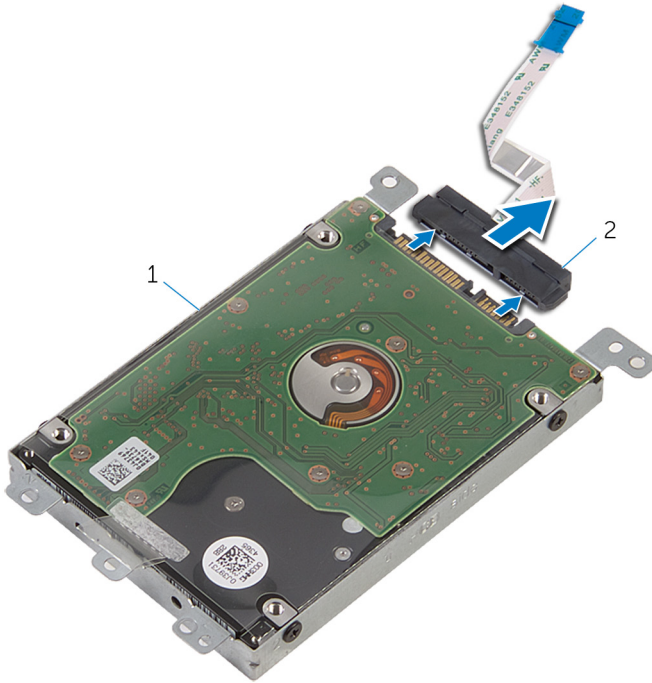

1 hard-drive assembly

2 interposer

- 5 Remove the screws that secure the hard-drive bracket to the hard drive.

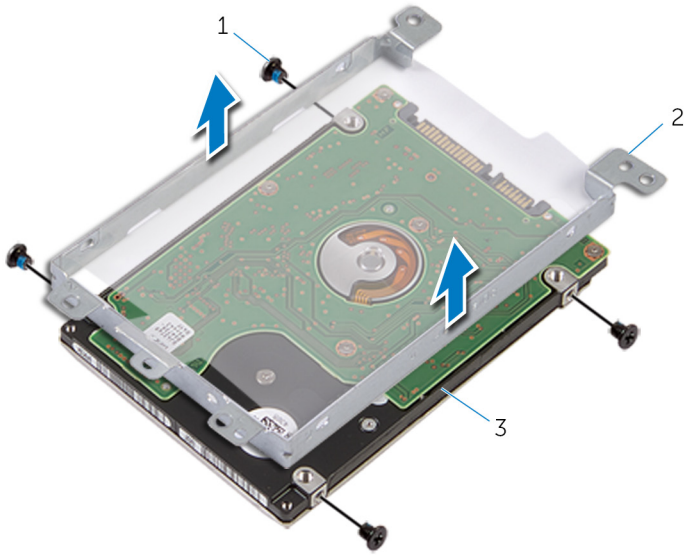

6 Lift the hard-drive bracket out of the hard drive.



- 1 screws (4)
- 3 hard drive

2 hard-drive bracket

Replacing the hard drive

-  **WARNING:** Before working inside your computer, read the safety information that shipped with your computer and follow the steps in [Before working inside your computer](#). After working inside your computer, follow the instructions in [After working inside your computer](#). For more safety best practices, see the Regulatory Compliance home page at dell.com/regulatory_compliance.
-  **CAUTION:** Hard drives are fragile. Exercise care when handling the hard drive.

Procedure

- 1 Place the hard-drive bracket on the hard drive.
- 2 Align the screw holes on the hard-drive bracket with the screw holes on the hard drive.
- 3 Replace the screws that secure the hard-drive bracket to the hard drive.
- 4 Connect the interposer to the hard drive.
- 5 Place the hard-drive assembly in the computer base and align the screw holes on the hard-drive assembly with the screw holes on the computer base.
- 6 Replace the screws that secure the hard-drive assembly to the computer base.
- 7 Slide the hard-drive cable into the connector and press down on the latch to secure the cable to the system board.

Post-requisites

- 1 Replace the [base cover](#).
- 2 Replace the [battery](#).

Removing the wireless card



WARNING: Before working inside your computer, read the safety information that shipped with your computer and follow the steps in [Before working inside your computer](#). After working inside your computer, follow the instructions in [After working inside your computer](#). For more safety best practices, see the Regulatory Compliance home page at dell.com/regulatory_compliance.

Prerequisites

- 1 Remove the [battery](#).
- 2 Remove the [base cover](#).

Procedure

- 1 Remove the screw that secures the wireless-card bracket to the system board.
- 2 Lift the wireless-card bracket off the wireless card.
- 3 Disconnect the antenna cables from the wireless card.

4 Slide the wireless card out of the wireless-card slot.

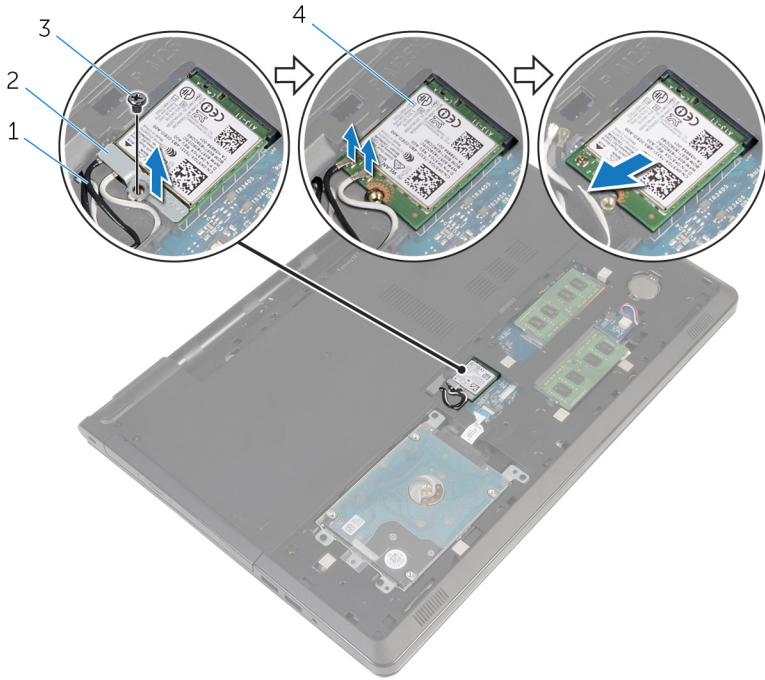

1 antenna cables (2)

3 screw

2 wireless-card bracket

4 wireless card

Replacing the wireless card

 **WARNING:** Before working inside your computer, read the safety information that shipped with your computer and follow the steps in [Before working inside your computer](#). After working inside your computer, follow the instructions in [After working inside your computer](#). For more safety best practices, see the Regulatory Compliance home page at dell.com/regulatory_compliance.

Procedure

 **CAUTION:** To avoid damage to the wireless card, do not place any cables under it.

- 1 Align the notch on the wireless card with the tab on the wireless-card slot.
- 2 Align the screw hole on the wireless card with the screw hole on the system board.
- 3 Slide the wireless card into the wireless-card slot.
- 4 Connect the antenna cables to the wireless card.

The following table provides the antenna-cable color scheme for the wireless card supported by your computer.



Connectors on the wireless card	Antenna-cable color
Main (white triangle)	white
Auxiliary (black triangle)	black

- 5 Place the wireless-card bracket on the wireless card and align the screw hole on the wireless-card bracket with the screw hole on the system board.
- 6 Replace the screw that secures the wireless card to the system board.

Post-requisites

- 1 Replace the [base cover](#).
- 2 Replace the [battery](#).

Removing the coin-cell battery

-  **WARNING:** Before working inside your computer, read the safety information that shipped with your computer and follow the steps in [Before working inside your computer](#). After working inside your computer, follow the instructions in [After working inside your computer](#). For more safety best practices, see the Regulatory Compliance home page at dell.com/regulatory_compliance.
-  **CAUTION:** Removing the coin-cell battery resets the BIOS setup program's settings to default. It is recommended that you note the BIOS setup program's settings before removing the coin-cell battery.

Prerequisites

- 1 Remove the [battery](#).
- 2 Remove the [base cover](#).

Procedure

Using a plastic scribe, gently pry out the coin-cell battery out of the battery socket on the system board.



- 1 plastic scribe
- 3 battery socket

- 2 coin-cell battery

Replacing the coin-cell battery



WARNING: Before working inside your computer, read the safety information that shipped with your computer and follow the steps in [Before working inside your computer](#). After working inside your computer, follow the instructions in [After working inside your computer](#). For more safety best practices, see the Regulatory Compliance home page at dell.com/regulatory_compliance.

Procedure

With the positive-side facing up, snap the coin-cell battery into the battery socket on the system board.

Post-requisites

- 1 Replace the [base cover](#).
- 2 Replace the [battery](#).

Removing the keyboard



WARNING: Before working inside your computer, read the safety information that shipped with your computer and follow the steps in [Before working inside your computer](#). After working inside your computer, follow the instructions in [After working inside your computer](#). For more safety best practices, see the Regulatory Compliance home page at dell.com/regulatory_compliance.

Prerequisites

Remove the [battery](#).

Procedure

- 1 Turn the computer over and, open the display.
- 2 Using a plastic scribe, pry the keyboard out by pressing the securing-clips.

- 3** Slide the keyboard up to release it from the tabs on the palm-rest assembly.

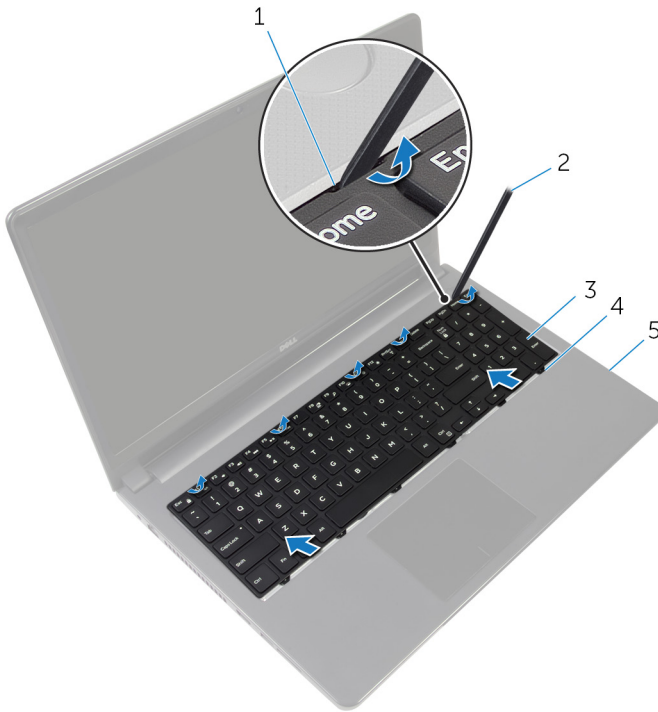

- | | | | |
|---|--------------------|---|----------------|
| 1 | securing clips (5) | 2 | plastic scribe |
| 3 | keyboard | 4 | tabs (6) |
| 5 | palm-rest assembly | | |

- 4** Turn the keyboard over and place it on the palm-rest assembly.

- 5** Lift the latches and disconnect the keyboard cable and backlight cable from the system board.

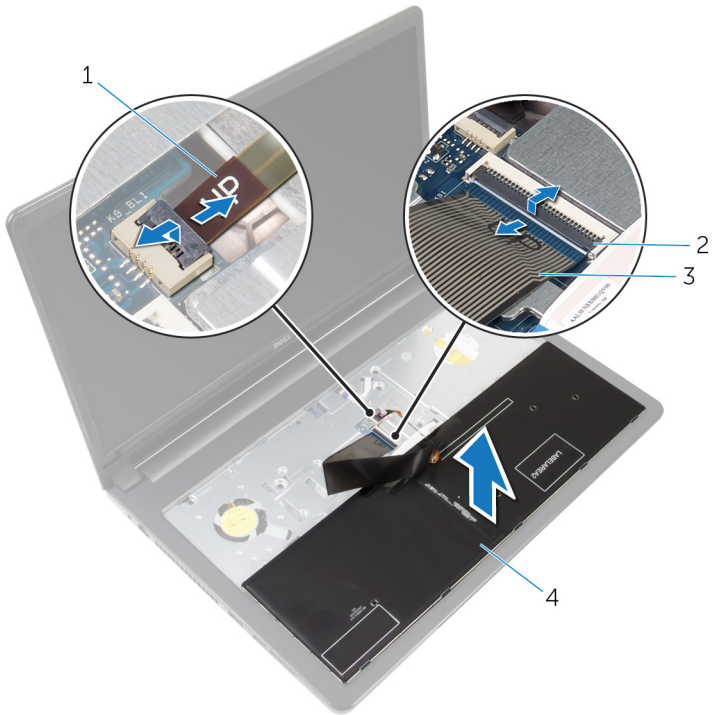

- | | | | |
|---|-----------------|---|-------------|
| 1 | backlight cable | 2 | latches (2) |
| 3 | keyboard cable | 4 | keyboard |

- 6** Lift the keyboard off the palm-rest assembly.

Replacing the keyboard



WARNING: Before working inside your computer, read the safety information that shipped with your computer and follow the steps in [Before working inside your computer](#). After working inside your computer, follow the instructions in [After working inside your computer](#). For more safety best practices, see the Regulatory Compliance home page at dell.com/regulatory_compliance.

Procedure

- 1 Slide the keyboard cable and the backlight cable into the connectors on the system board and press down on the latches to secure the cables.
- 2 Turn over the keyboard.
- 3 Slide the tabs on the keyboard into the slots on the palm-rest assembly and snap the keyboard into place.

Post-requisites

Replace the [battery](#).

Removing the computer base



WARNING: Before working inside your computer, read the safety information that shipped with your computer and follow the steps in [Before working inside your computer](#). After working inside your computer, follow the instructions in [After working inside your computer](#). For more safety best practices, see the Regulatory Compliance home page at dell.com/regulatory_compliance.

Prerequisites

- 1 Remove the [battery](#).
- 2 Remove the [optical drive](#).
- 3 Remove the [base cover](#).
- 4 Remove the [hard drive](#).
- 5 Remove the [wireless card](#).
- 6 Remove the [keyboard](#).

Procedure

- 1 Lift the latch and disconnect the optical-drive cable from the system board.

- 2 Remove the screws that secure the computer base to the palm-rest assembly.

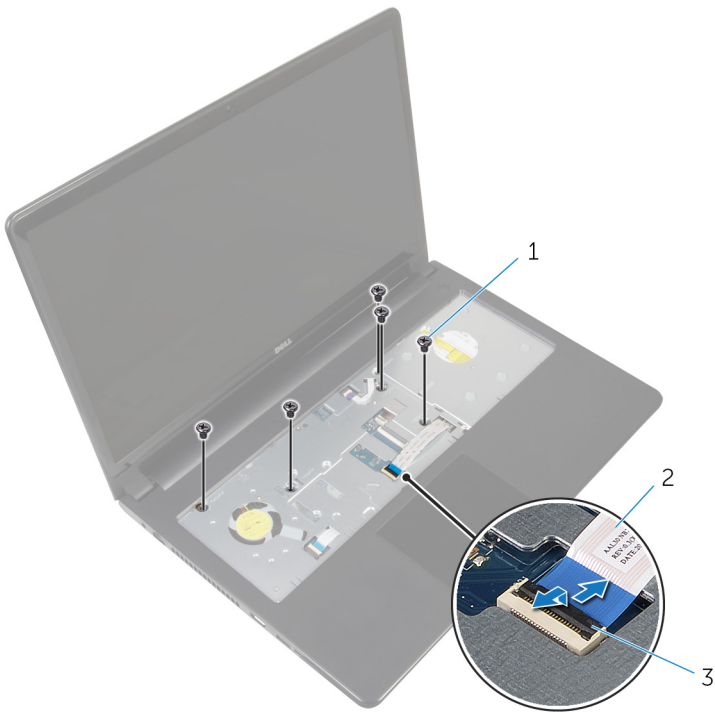

- 1 screws (5)
- 3 latch

- 2 optical-drive cable

- 3 Close the display and turn the computer over.
- 4 Disconnect the speaker cable from its connector on the system board.

- 5** Remove the screws that secure the computer base to the palm-rest assembly.

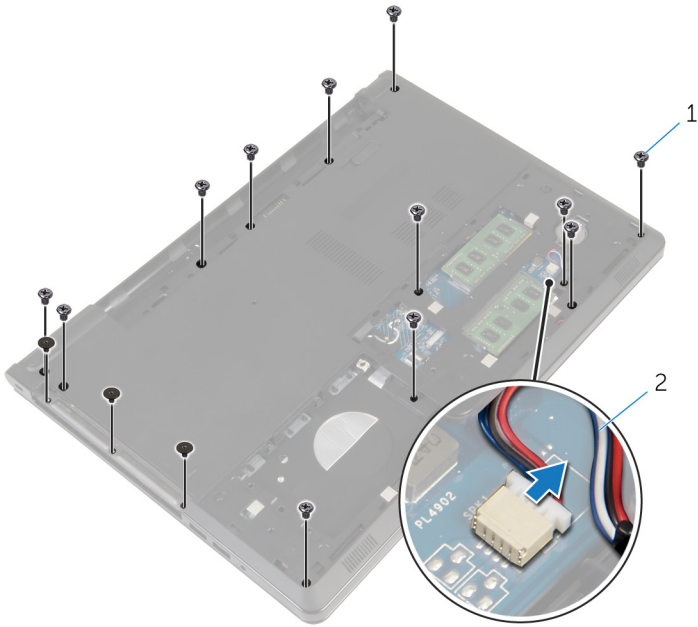

1 screws (15)

2 speaker cable

- 6** Using your fingertips, pry up the computer base from the palm-rest assembly starting from the area around the display hinges.

- 7** Lift the computer base off the palm-rest assembly and slide the antenna cables through the computer base.

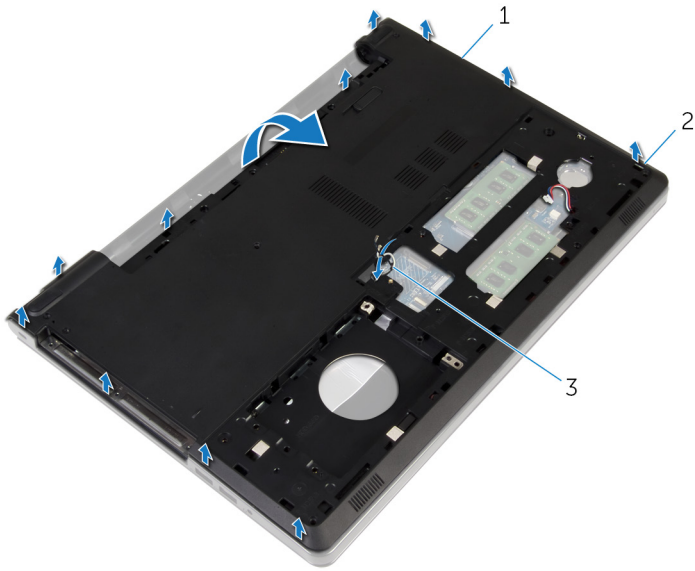

- 1 computer base 2 tabs
3 antenna cables

- 8** Follow the procedure from step 2 to step 4 in "[Removing the speakers](#)".

- 9 Lift the optical-drive interposer along with the cable off the computer base.

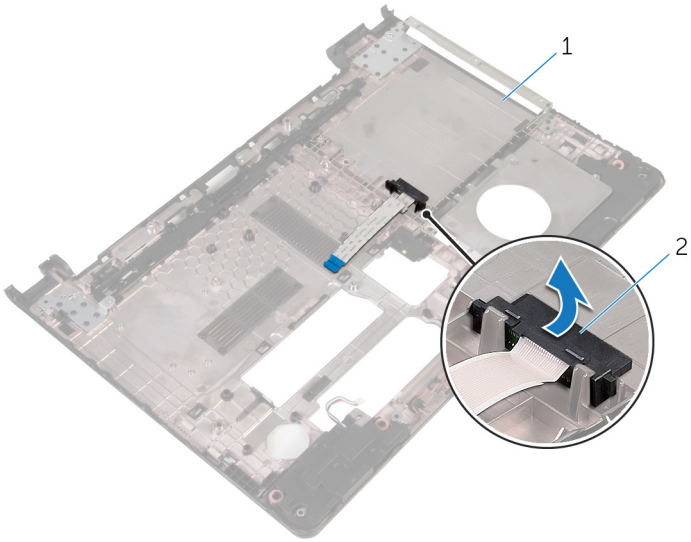

1 optical-drive interposer

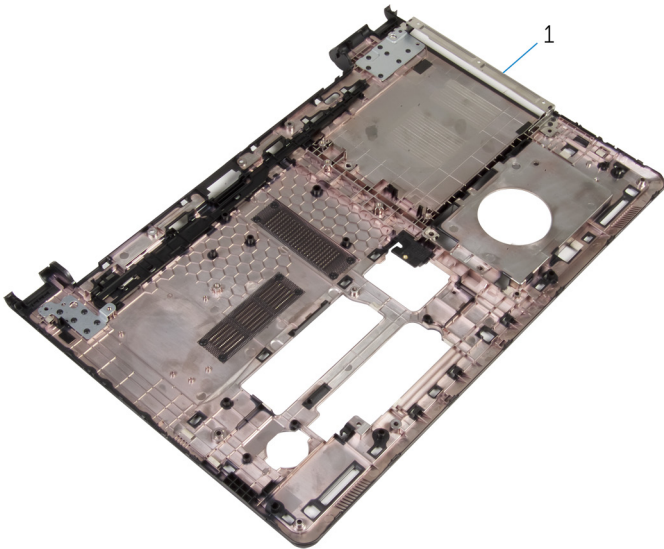

1 computer base

Replacing the computer base



WARNING: Before working inside your computer, read the safety information that shipped with your computer and follow the steps in [Before working inside your computer](#). After working inside your computer, follow the instructions in [After working inside your computer](#). For more safety best practices, see the Regulatory Compliance home page at dell.com/regulatory_compliance.

Procedure

- 1 Replace the optical-drive interposer on the computer base.
- 2 Follow the procedure from step 1 to step 3 in "[Replacing the speakers](#)".
- 3 Route the antenna cables through the slot on the computer base.
- 4 Press the computer base down along the edges to snap it into place.
- 5 Replace the screws that secure the computer base to the palm-rest assembly.
- 6 Turn the computer over and open the display.
- 7 Replace the screws that secure the computer base to the palm-rest assembly.
- 8 Slide the optical-drive cable in the connector and press down on the latch to secure the cable.

Post-requisites

- 1 Replace the [keyboard](#).
- 2 Replace the [wireless card](#).
- 3 Replace the [hard drive](#).
- 4 Replace the [base cover](#).
- 5 Replace the [optical drive](#).
- 6 Replace the [battery](#).

Removing the optical-drive interposer



WARNING: Before working inside your computer, read the safety information that shipped with your computer and follow the steps in [Before working inside your computer](#). After working inside your computer, follow the instructions in [After working inside your computer](#). For more safety best practices, see the Regulatory Compliance home page at dell.com/regulatory_compliance.

Prerequisites

- 1 Remove the [battery](#).
- 2 Remove the [optical drive](#).
- 3 Remove the [base cover](#).
- 4 Remove the [hard drive](#).
- 5 Remove the [wireless card](#).
- 6 Remove the [keyboard](#).

Procedure

- 1 Follow the procedure from step 1 to step 7 in "[Removing the computer base](#)".

- 2 Lift the optical-drive interposer along with the cable off the computer base.

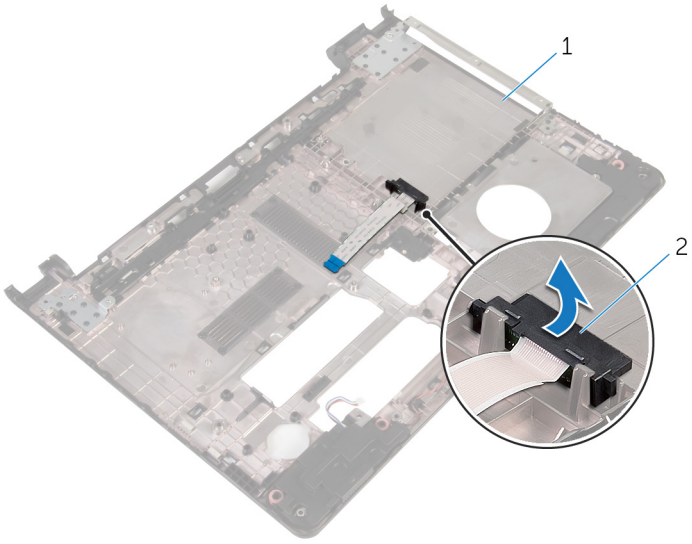

1 computer base

2 optical-drive interposer

Replacing the optical-drive interposer

 **WARNING:** Before working inside your computer, read the safety information that shipped with your computer and follow the steps in [Before working inside your computer](#). After working inside your computer, follow the instructions in [After working inside your computer](#). For more safety best practices, see the Regulatory Compliance home page at dell.com/regulatory_compliance.

Procedure

- 1 Replace the optical-drive interposer on the computer base.
- 2 Follow the procedure from step 3 to step 8 in "[Replacing the computer base](#)".

Post-requisites

- 1 Replace the [keyboard](#).
- 2 Replace the [wireless card](#).
- 3 Replace the [hard drive](#).
- 4 Replace the [base cover](#).
- 5 Replace the [optical drive](#).
- 6 Replace the [battery](#).

Removing the speakers



WARNING: Before working inside your computer, read the safety information that shipped with your computer and follow the steps in [Before working inside your computer](#). After working inside your computer, follow the instructions in [After working inside your computer](#). For more safety best practices, see the Regulatory Compliance home page at dell.com/regulatory_compliance.

Prerequisites

- 1 Remove the [battery](#).
- 2 Remove the [optical drive](#).
- 3 Remove the [base cover](#).
- 4 Remove the [hard drive](#).
- 5 Remove the [wireless card](#).
- 6 Remove the [keyboard](#).

Procedure

- 1 Follow the procedure from step 1 to step 7 in "[Removing the computer base](#)".
- 2 Turn the computer base over.
- 3 Note the speaker-cable routing and the position of the rubber grommets on the computer base.

4 Lift the speakers, along with the speaker cable, off the computer base.

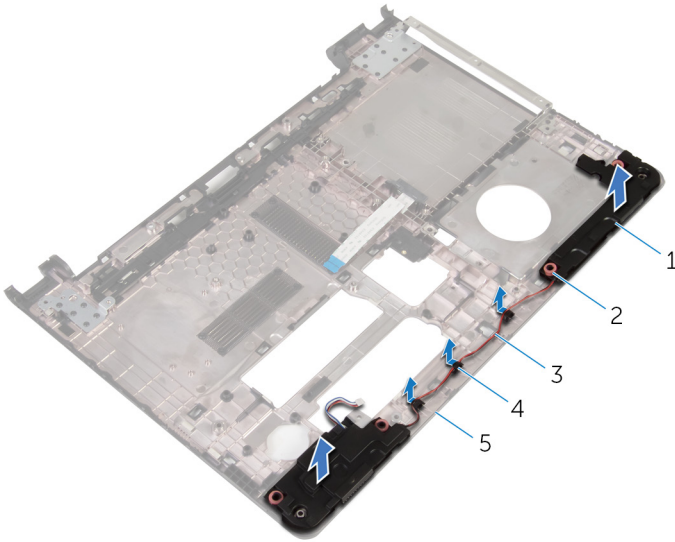

- | | | | |
|---|---------------|---|---------------------|
| 1 | speakers (2) | 2 | rubber grommets (4) |
| 3 | speaker cable | 4 | routing guides |
| 5 | computer base | | |

Replacing the speakers



WARNING: Before working inside your computer, read the safety information that shipped with your computer and follow the steps in [Before working inside your computer](#). After working inside your computer, follow the instructions in [After working inside your computer](#). For more safety best practices, see the Regulatory Compliance home page at dell.com/regulatory_compliance.

Procedure

- 1 Using the alignment posts on the computer base, place the speakers on the computer base.
- 2 Route the speaker cable through the routing guides on the computer base.
- 3 Replace the rubber grommets if they are pushed up while replacing the speakers.
- 4 Follow the procedure from step 3 to step 8 in "[Replacing the computer base](#)".

Post-requisites

- 1 Replace the [keyboard](#).
- 2 Replace the [wireless card](#).
- 3 Replace the [hard drive](#).
- 4 Replace the [base cover](#).
- 5 Replace the [optical drive](#).
- 6 Replace the [battery](#).

Removing the I/O board



WARNING: Before working inside your computer, read the safety information that shipped with your computer and follow the steps in [Before working inside your computer](#). After working inside your computer, follow the instructions in [After working inside your computer](#). For more safety best practices, see the Regulatory Compliance home page at dell.com/regulatory_compliance.

Prerequisites

- 1 Remove the [battery](#).
- 2 Remove the [optical drive](#).
- 3 Remove the [base cover](#).
- 4 Remove the [hard drive](#).
- 5 Remove the [wireless card](#).
- 6 Remove the [keyboard](#).
- 7 Follow the procedure from step 1 to step 7 in "[Removing the computer base](#)".

Procedure

- 1 Remove the screw that secures the I/O board to the palm-rest assembly.
- 2 Lift the I/O board and turn it over.
- 3 Lift the latch and, using the pull-tab disconnect the I/O-board cable from the I/O board.

4 Lift the I/O board off the palm-rest assembly.

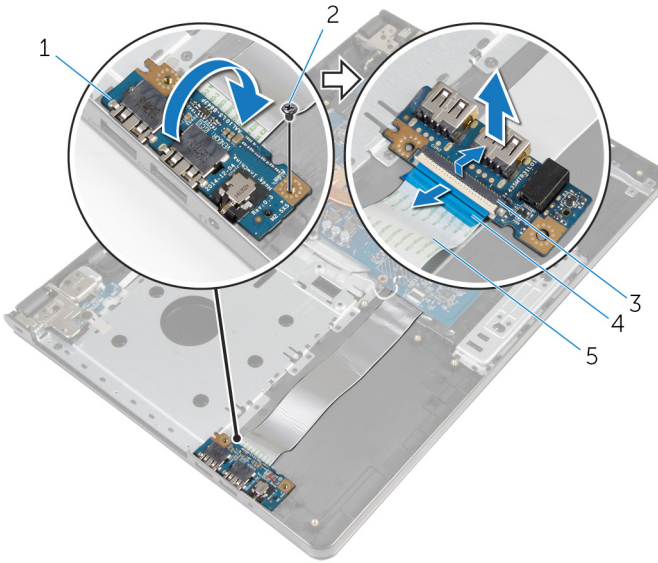

- 1 I/O board
- 3 latch
- 5 I/O-board cable

- 2 screw
- 4 pull-tab

Replacing the I/O board



WARNING: Before working inside your computer, read the safety information that shipped with your computer and follow the steps in [Before working inside your computer](#). After working inside your computer, follow the instructions in [After working inside your computer](#). For more safety best practices, see the Regulatory Compliance home page at dell.com/regulatory_compliance.



Procedure

- 1 Slide the I/O-board cable into the I/O-board cable connector and press down on the latch to secure the cable.
- 2 Turn over the I/O board and align the screw hole on the I/O board with the screw hole on the palm-rest assembly.
- 3 Replace the screw that secures the I/O board to the palm-rest assembly.

Post-requisites

- 1 Follow the procedure from step 3 to step 8 in "[Replacing the computer base](#)".
- 2 Replace the [keyboard](#).
- 3 Replace the [wireless card](#).
- 4 Replace the [hard drive](#).
- 5 Replace the [base cover](#).
- 6 Replace the [optical drive](#).
- 7 Replace the [battery](#).

Removing the heat-sink assembly

-  **WARNING:** Before working inside your computer, read the safety information that shipped with your computer and follow the steps in [Before working inside your computer](#). After working inside your computer, follow the instructions in [After working inside your computer](#). For more safety best practices, see the Regulatory Compliance home page at dell.com/regulatory_compliance.
-  **WARNING:** The heat sink may become hot during normal operation. Allow sufficient time for the heat sink to cool before you touch it.
-  **CAUTION:** For maximum cooling of the processor, do not touch the heat transfer areas on the heat sink. The oils in your skin can reduce the heat transfer capability of the thermal grease.

Prerequisites

- 1 Remove the [battery](#).
- 2 Remove the [optical drive](#).
- 3 Remove the [base cover](#).
- 4 Remove the [hard drive](#).
- 5 Remove the [wireless card](#).
- 6 Remove the [keyboard](#).
- 7 Follow the procedure from step 1 to step 7 in "[Removing the computer base](#)".

Procedure

-  **NOTE:** The number of screws and the appearance of the heat-sink assembly may be different on your computer depending on the configuration you ordered.

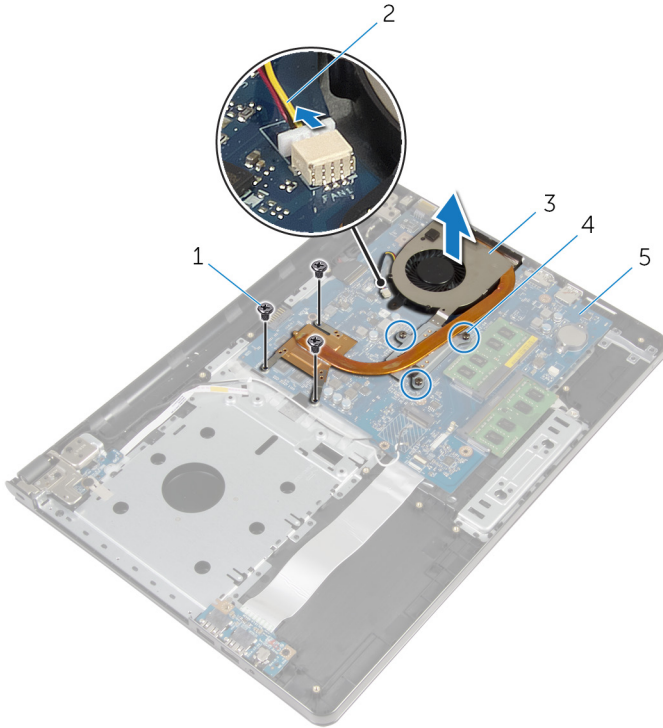

- 1 Disconnect the fan cable from the system board.
- 2 In sequential order (indicated on the heat-sink assembly), loosen the captive screws that secure the heat-sink assembly to the system board.

- 3 In sequential order (indicated on the heat-sink assembly), remove the screws that secure the heat-sink assembly to the system board.
- 4 Lift the heat-sink assembly off the system board.



- | | | | |
|---|--------------------|---|--------------------|
| 1 | screws (3) | 2 | fan cable |
| 3 | heat-sink assembly | 4 | captive screws (3) |
| 5 | system board | | |

Replacing the heat-sink assembly

-  **WARNING:** Before working inside your computer, read the safety information that shipped with your computer and follow the steps in [Before working inside your computer](#). After working inside your computer, follow the instructions in [After working inside your computer](#). For more safety best practices, see the Regulatory Compliance home page at dell.com/regulatory_compliance.
-  **CAUTION:** Incorrect alignment of the heat sink can cause damage to the system board and processor.
-  **NOTE:** The original thermal grease can be reused if the original system board and fan are reinstalled together. If either the system board or the fan is replaced, use the thermal pad provided in the kit to ensure that thermal conductivity is achieved.

Procedure

- 1 Place the heat-sink assembly on the system board.
- 2 Align the screw holes on the heat-sink assembly with the screw holes on the system board.
- 3 In sequential order (indicated on the heat-sink assembly), replace the screws that secure the heat-sink assembly to the system board.
- 4 In sequential order (indicated on the heat-sink assembly), tighten the captive screws that secure the heat-sink assembly to the system board.
- 5 Connect the fan cable to the system board.

Post-requisites

- 1 Follow the procedure from step 3 to step 8 in "[Replacing the computer base](#)".
- 2 Replace the [keyboard](#).
- 3 Replace the [wireless card](#).
- 4 Replace the [hard drive](#).
- 5 Replace the [base cover](#).
- 6 Replace the [optical drive](#).

7 Replace the [battery](#).

Removing the power-button module



WARNING: Before working inside your computer, read the safety information that shipped with your computer and follow the steps in [Before working inside your computer](#). After working inside your computer, follow the instructions in [After working inside your computer](#). For more safety best practices, see the Regulatory Compliance home page at dell.com/regulatory_compliance.

Prerequisites

- 1 Remove the [battery](#).
- 2 Remove the [optical drive](#).
- 3 Remove the [base cover](#).
- 4 Remove the [hard drive](#).
- 5 Remove the [wireless card](#).
- 6 Remove the [keyboard](#).
- 7 Follow the procedure from step 1 to step 7 in "[Removing the computer base](#)".

Procedure

- 1 Turn the computer over and open the display.
- 2 Disconnect the power-button board cable from the system board.

- 3 Slide the power-button board cable out through the slot on the palm-rest assembly.

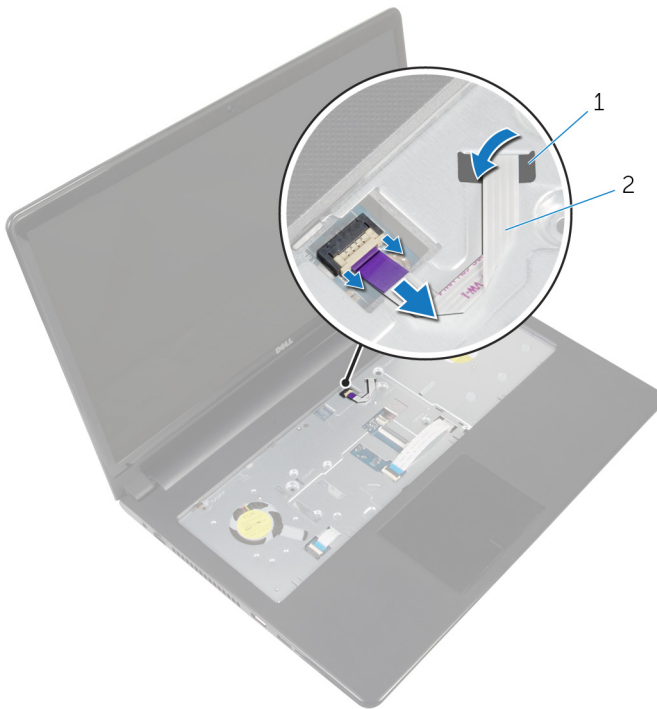

1 slot

2 power-button board cable

- 4 Close the display and turn the computer over.
- 5 Remove the screw that secures the power-button board to the palm-rest assembly.
- 6 Peel off the tape from the power-button board.

7 Lift the power-button board at an angle along with the cable off the palm-rest assembly.

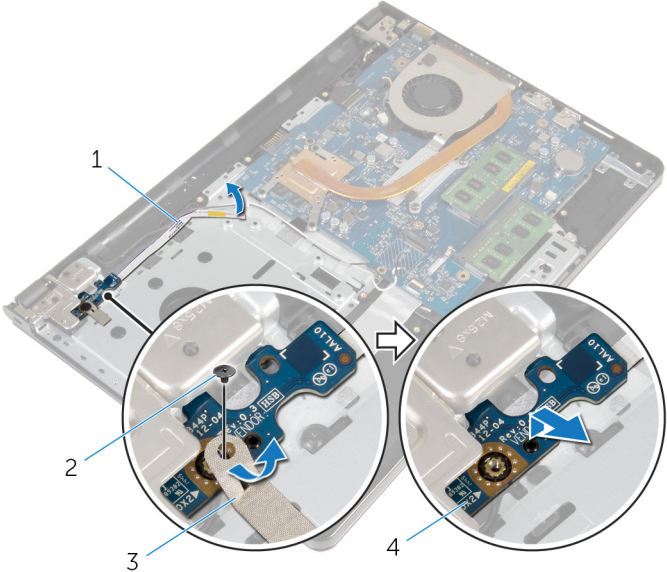

1 power-button board cable

2 screw

3 tape

4 power-button board

Replacing the power-button module

 **WARNING:** Before working inside your computer, read the safety information that shipped with your computer and follow the steps in [Before working inside your computer](#). After working inside your computer, follow the instructions in [After working inside your computer](#). For more safety best practices, see the Regulatory Compliance home page at dell.com/regulatory_compliance.

Procedure

- 1 Align the screw hole on the power-button board with the screw hole on the palm-rest assembly.
- 2 Adhere the tape on the power-button board.
- 3 Replace the screw that secures the power-button board to the palm-rest assembly.
- 4 Slide the cable through the slot on the palm-rest assembly.
- 5 Turn the computer over and open the display.
- 6 Connect the power-button board cable to the system board.

Post-requisites

- 1 Follow the procedure from step 3 to step 8 in "[Replacing the computer base](#)".
- 2 Replace the [keyboard](#).
- 3 Replace the [wireless card](#).
- 4 Replace the [hard drive](#).
- 5 Replace the [base cover](#).
- 6 Replace the [optical drive](#).
- 7 Replace the [battery](#).

Removing the system board



WARNING: Before working inside your computer, read the safety information that shipped with your computer and follow the steps in [Before working inside your computer](#). After working inside your computer, follow the instructions in [After working inside your computer](#). For more safety best practices, see the Regulatory Compliance home page at dell.com/regulatory_compliance.



NOTE: Your computer's Service Tag is stored in the system board. You must enter the Service Tag in the BIOS setup program after you replace the system board.



NOTE: Replacing the system board removes any changes you have made to the BIOS using the BIOS setup program. You must make the desired changes again after you replace the system board.



NOTE: Before disconnecting the cables from the system board, note the location of the connectors so that you can reconnect them correctly after you replace the system board.

Prerequisites

- 1 Remove the [battery](#).
- 2 Remove the [optical drive](#).
- 3 Remove the [base cover](#).
- 4 Remove the [hard drive](#).
- 5 Remove the [wireless card](#).
- 6 Remove the [keyboard](#).
- 7 Follow the procedure from step 1 to step 7 in "[Removing the computer base](#)".
- 8 Remove the [I/O board](#).

Procedure

- 1 Turn the computer over and open the display.
- 2 Disconnect the power-button board cable from the system board.

- 3 Lift the latch and disconnect the touchpad cable from the connector on the system board.

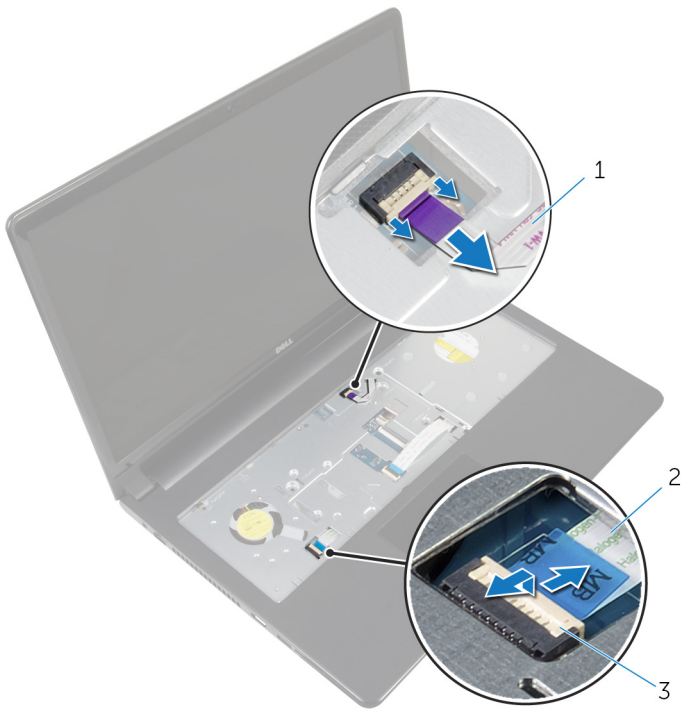

- | | | | |
|---|--------------------------|---|----------------|
| 1 | power-button board cable | 2 | touchpad cable |
| 3 | latch | | |

- 4 Close the display panel and turn the computer over.
- 5 Lift the latch and disconnect the display cable from the connector on the system board.

- 6 Remove the screw that secures the system board to the palm-rest assembly.

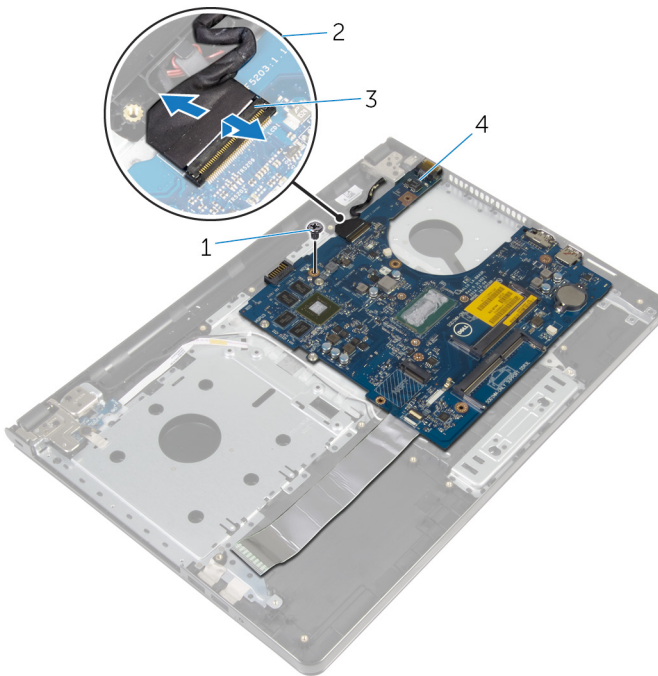

1 screw

2 display cable

3 latch

4 system board

- 7 Carefully lift the system board from the inner edge and release the ports from the slots on the palm-rest assembly.

- 8** Turn the system board over.

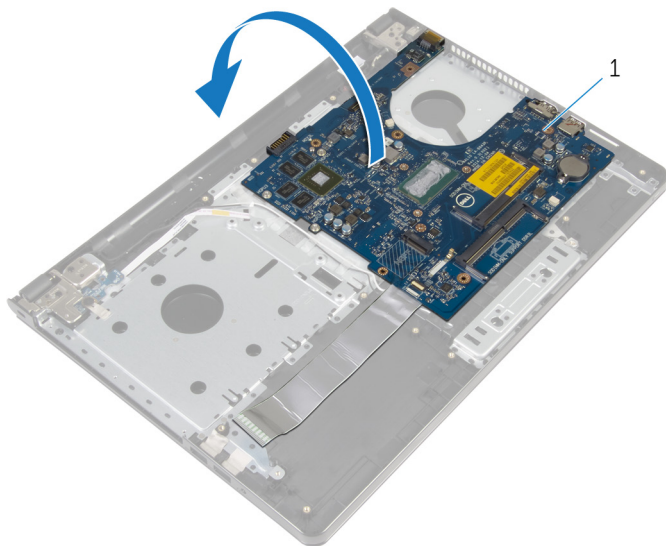

1 system board

- 9** Lift the latch and disconnect the I/O-board cable from the system board.
10 Disconnect the power-adaptor port cable from the system board.

11 Lift the system board off the palm-rest assembly.

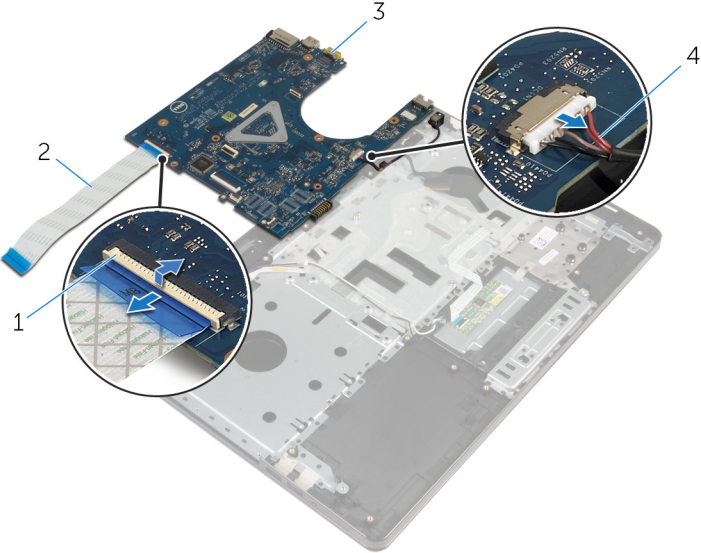

1 latch

3 system board

2 I/O-board cable

4 power-adaptor port cable

Replacing the system board



WARNING: Before working inside your computer, read the safety information that shipped with your computer and follow the steps in [Before working inside your computer](#). After working inside your computer, follow the instructions in [After working inside your computer](#). For more safety best practices, see the Regulatory Compliance home page at dell.com/regulatory_compliance.



NOTE: Your computer's Service Tag is stored in the system board. You must enter the Service Tag in the BIOS setup program after you replace the system board.



NOTE: Replacing the system board removes any changes you have made to the BIOS using the BIOS setup program. You must make the desired changes again after you replace the system board.

Procedure

- 1 Connect the power-adaptor port cable to the system board.
- 2 Slide the I/O-board cable into the connector and press down on the latch to secure the cable to the system board.
- 3 Turn the system board over.
- 4 Slide the ports on the system board into the slots on the palm-rest assembly and place the system board on the palm-rest assembly.
- 5 Align the screw hole on the system board with the screw hole on the palm-rest assembly.
- 6 Replace the screw that secures the system board to the palm-rest assembly.
- 7 Slide the display cable into the connector and press down on the latch to secure the cable to the system board.
- 8 Turn the computer over and open the display.
- 9 Slide the touchpad cable into the connector and press down on the latch to secure the cable.
- 10 Connect the power-button board cable to the system board.

Post-requisites

- 1 Replace the [I/O board](#).

- 2 Follow the procedure from step 3 to step 8 in "[Replacing the computer base](#)".
- 3 Replace the [keyboard](#).
- 4 Replace the [wireless card](#).
- 5 Replace the [hard drive](#).
- 6 Replace the [base cover](#).
- 7 Replace the [optical drive](#).
- 8 Replace the [battery](#).

Removing the display assembly



WARNING: Before working inside your computer, read the safety information that shipped with your computer and follow the steps in [Before working inside your computer](#). After working inside your computer, follow the instructions in [After working inside your computer](#). For more safety best practices, see the Regulatory Compliance home page at dell.com/regulatory_compliance.

Prerequisites

- 1 Remove the [battery](#).
- 2 Remove the [optical drive](#).
- 3 Remove the [base cover](#).
- 4 Remove the [hard drive](#).
- 5 Remove the [wireless card](#).
- 6 Remove the [keyboard](#).
- 7 Follow the procedure from step 1 to step 7 in "[Removing the computer base](#)".

Procedure

- 1 Note the antenna cable routing and remove the cable from its routing guides.
- 2 Lift the latch and disconnect the display cable from the system board.

- 3** Note the display cable routing and remove the cable from its routing guides.

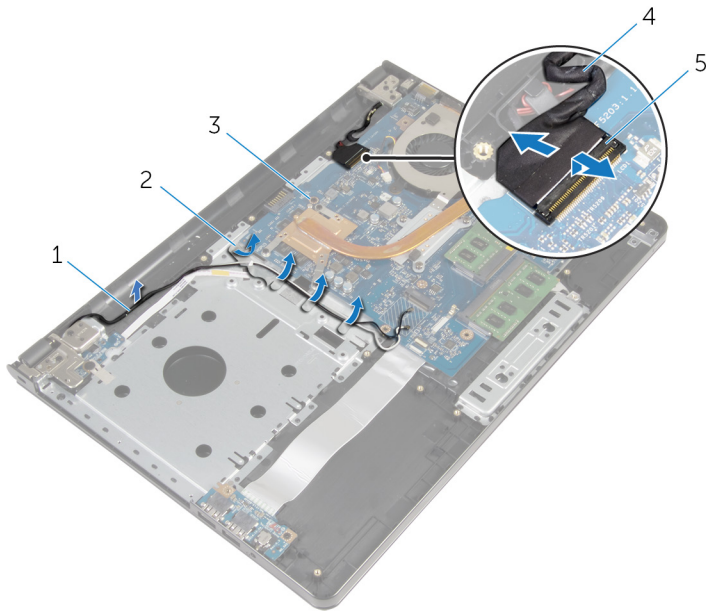

- | | | | |
|---|----------------|---|----------------|
| 1 | antenna cables | 2 | routing guides |
| 3 | system board | 4 | display cable |
| 5 | latch | | |

- 4** Turn the computer over.
- 5** Open the display at an angle of 90 degrees.
- 6** Place the computer on the edge of the table so that the palm-rest assembly is on the table and the display assembly extends past the table edge with the display hinges facing up.
- 7** Remove the screws that secure the display hinges to the palm-rest assembly.

8 Lift the display assembly off the palm-rest assembly.

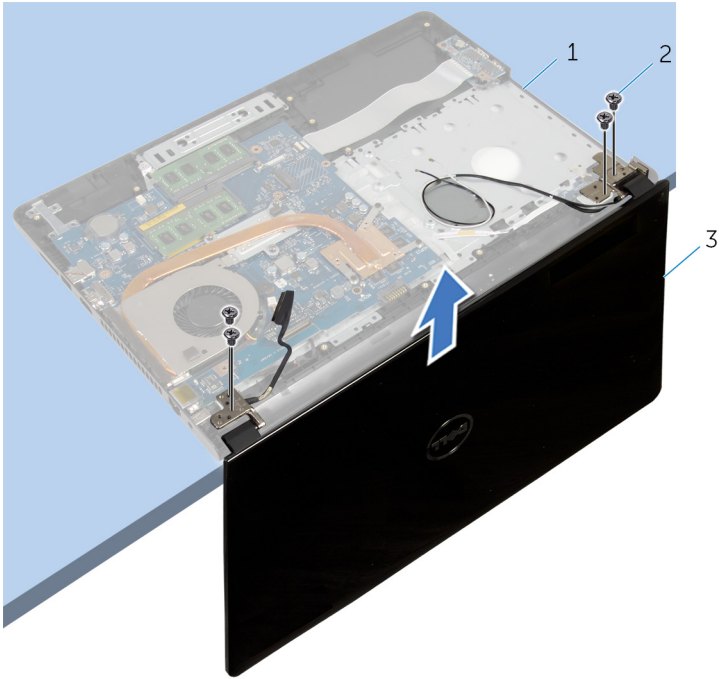

1 palm-rest assembly

2 screws (4)

3 display assembly

Replacing the display assembly



WARNING: Before working inside your computer, read the safety information that shipped with your computer and follow the steps in [Before working inside your computer](#). After working inside your computer, follow the instructions in [After working inside your computer](#). For more safety best practices, see the Regulatory Compliance home page at dell.com/regulatory_compliance.

Procedure

- 1 Place the palm-rest assembly at the edge of the table with the coin-cell battery facing away from the edge.
- 2 Align the screw holes on the display hinges with the screw holes on the palm-rest assembly.
- 3 Replace the screws that secure the display hinges to the palm-rest assembly.
- 4 Close the display and turn the computer over.
- 5 Route the display cable through the routing guides on the palm-rest assembly.
- 6 Slide the display cable to the connector and press down on the latch to connect the display cable to the system board.
- 7 Route the antenna cable through the routing guides on the palm-rest assembly.

Post-requisites

- 1 Follow the procedure from step 3 to step 8 in "[Replacing the computer base](#)".
- 2 Replace the [keyboard](#).
- 3 Replace the [wireless card](#).
- 4 Replace the [hard drive](#).
- 5 Replace the [base cover](#).
- 6 Replace the [optical drive](#).
- 7 Replace the [battery](#).

Removing the display bezel



WARNING: Before working inside your computer, read the safety information that shipped with your computer and follow the steps in [Before working inside your computer](#). After working inside your computer, follow the instructions in [After working inside your computer](#). For more safety best practices, see the Regulatory Compliance home page at dell.com/regulatory_compliance.

Prerequisites

- 1 Remove the [battery](#).
- 2 Remove the [optical drive](#).
- 3 Remove the [base cover](#).
- 4 Remove the [hard drive](#).
- 5 Remove the [wireless card](#).
- 6 Remove the [keyboard](#).
- 7 Follow the procedure from step 1 to step 7 in "[Removing the computer base](#)".
- 8 Remove the [display assembly](#).

Procedure

- 1 Using your fingertips, carefully pry up the inside edge of the display bezel.

2 Remove the display bezel off the display back-cover.



1 display bezel

2 display back-cover

Replacing the display bezel



WARNING: Before working inside your computer, read the safety information that shipped with your computer and follow the steps in [Before working inside your computer](#). After working inside your computer, follow the instructions in [After working inside your computer](#). For more safety best practices, see the Regulatory Compliance home page at dell.com/regulatory_compliance.

Procedure

Align the display bezel with the display back-cover, and gently snap the display bezel into place.

Post-requisites

- 1 Replace the [display assembly](#).
- 2 Follow the procedure from step 3 to step 8 in "[Replacing the computer base](#)".
- 3 Replace the [keyboard](#).
- 4 Replace the [wireless card](#).
- 5 Replace the [hard drive](#).
- 6 Replace the [base cover](#).
- 7 Replace the [optical drive](#).
- 8 Replace the [battery](#).

Removing the display panel



WARNING: Before working inside your computer, read the safety information that shipped with your computer and follow the steps in [Before working inside your computer](#). After working inside your computer, follow the instructions in [After working inside your computer](#). For more safety best practices, see the Regulatory Compliance home page at dell.com/regulatory_compliance.

Prerequisites

- 1 Remove the [battery](#).
- 2 Remove the [optical drive](#).
- 3 Remove the [base cover](#).
- 4 Remove the [hard drive](#).
- 5 Remove the [wireless card](#).
- 6 Remove the [keyboard](#).
- 7 Follow the procedure from step 1 to step 7 in "[Removing the computer base](#)".
- 8 Remove the [display assembly](#).
- 9 Remove the [display bezel](#).

Procedure

- 1 Remove the screws that secure the display panel to the display back-cover.

2 Gently lift the display panel and turn it over.

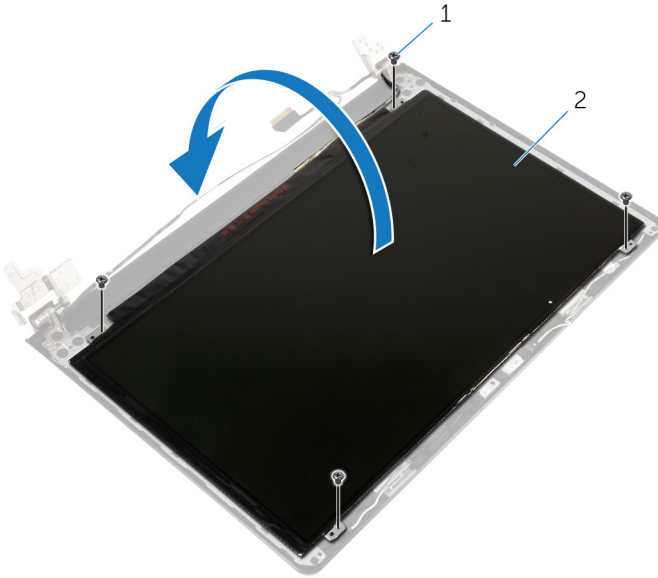

1 screws (4)

2 display panel

3 Peel the tape adhered over the display cable.

- 4 Disconnect the display cable from the display-panel cable connector.

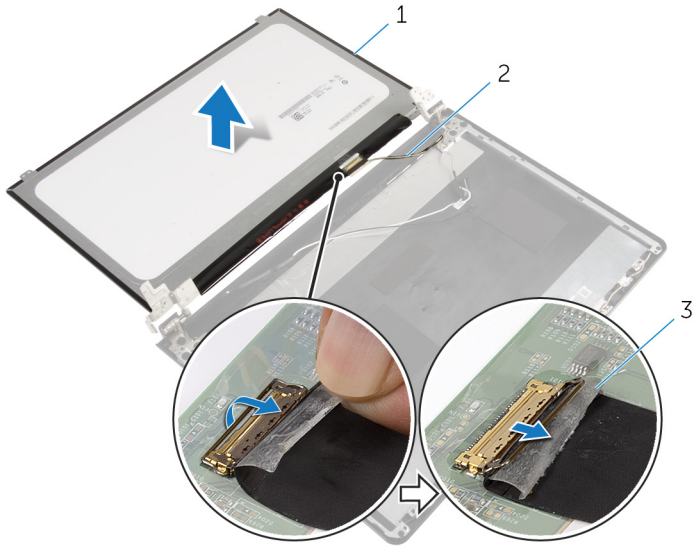

1 display panel
3 tape

2 display cable

- 5 Lift the display panel away from the display back-cover.

Replacing the display panel



WARNING: Before working inside your computer, read the safety information that shipped with your computer and follow the steps in [Before working inside your computer](#). After working inside your computer, follow the instructions in [After working inside your computer](#). For more safety best practices, see the Regulatory Compliance home page at dell.com/regulatory_compliance.

Procedure

- 1 Connect the display cable to the display-panel connector.
- 2 Adhere the tape that secures the display cable.
- 3 Gently place the display panel on the display back-cover and align the screw holes on the display panel with the screw holes on the display back-cover.
- 4 Replace the screws that secure the display panel to the display back-cover.

Post-requisites

- 1 Replace the [display bezel](#).
- 2 Replace the [display assembly](#).
- 3 Follow the procedure from step 3 to step 8 in "[Replacing the computer base](#)".
- 4 Replace the [keyboard](#).
- 5 Replace the [wireless card](#).
- 6 Replace the [hard drive](#).
- 7 Replace the [base cover](#).
- 8 Replace the [optical drive](#).
- 9 Replace the [battery](#).

Removing the display hinges



WARNING: Before working inside your computer, read the safety information that shipped with your computer and follow the steps in [Before working inside your computer](#). After working inside your computer, follow the instructions in [After working inside your computer](#). For more safety best practices, see the Regulatory Compliance home page at dell.com/regulatory_compliance.

Prerequisites

- 1 Remove the [battery](#).
- 2 Remove the [optical drive](#).
- 3 Remove the [base cover](#).
- 4 Remove the [hard drive](#).
- 5 Remove the [wireless card](#).
- 6 Remove the [keyboard](#).
- 7 Follow the procedure from step 1 to step 7 in "[Removing the computer base](#)".
- 8 Remove the [display assembly](#).
- 9 Remove the [display bezel](#).
- 10 Remove the [display panel](#).

Procedure

- 1 Remove the screws that secure the display hinges to the display back-cover.

2 Lift the display hinges off the display back-cover.

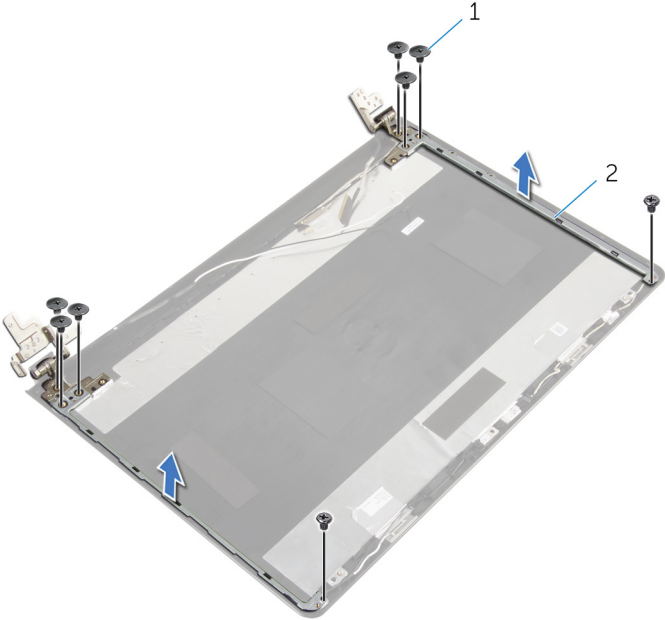

1 screws (8)

2 display hinges (2)

Replacing the display hinges



WARNING: Before working inside your computer, read the safety information that shipped with your computer and follow the steps in [Before working inside your computer](#). After working inside your computer, follow the instructions in [After working inside your computer](#). For more safety best practices, see the Regulatory Compliance home page at dell.com/regulatory_compliance.

Procedure

- 1 Align the screw holes on the display hinges with the screw holes on the display back-cover.
- 2 Replace the screws that secure the display hinges to the display back-cover.

Post-requisites

- 1 Replace the [display panel](#).
- 2 Replace the [display bezel](#).
- 3 Replace the [display assembly](#).
- 4 Follow the procedure from step 3 to step 8 in "[Replacing the computer base](#)".
- 5 Replace the [keyboard](#).
- 6 Replace the [wireless card](#).
- 7 Replace the [hard drive](#).
- 8 Replace the [base cover](#).
- 9 Replace the [optical drive](#).
- 10 Replace the [battery](#).

Removing the display cable



WARNING: Before working inside your computer, read the safety information that shipped with your computer and follow the steps in [Before working inside your computer](#). After working inside your computer, follow the instructions in [After working inside your computer](#). For more safety best practices, see the Regulatory Compliance home page at dell.com/regulatory_compliance.

Prerequisites

- 1 Remove the [battery](#).
- 2 Remove the [optical drive](#).
- 3 Remove the [base cover](#).
- 4 Remove the [hard drive](#).
- 5 Remove the [wireless card](#).
- 6 Remove the [keyboard](#).
- 7 Follow the procedure from step 1 to step 7 in "[Removing the computer base](#)".
- 8 Remove the [display assembly](#).
- 9 Remove the [display bezel](#).
- 10 Remove the [display panel](#).
- 11 Remove the [display hinges](#).

Procedure

- 1 Disconnect the camera cable from the connector on the camera module.
- 2 Peel off the tape that secures the camera cable to the display back-cover.
- 3 Note the camera cable routing and remove the camera cable from the display back-cover.

4 Note the display cable routing and remove the display cable from the display back-cover.

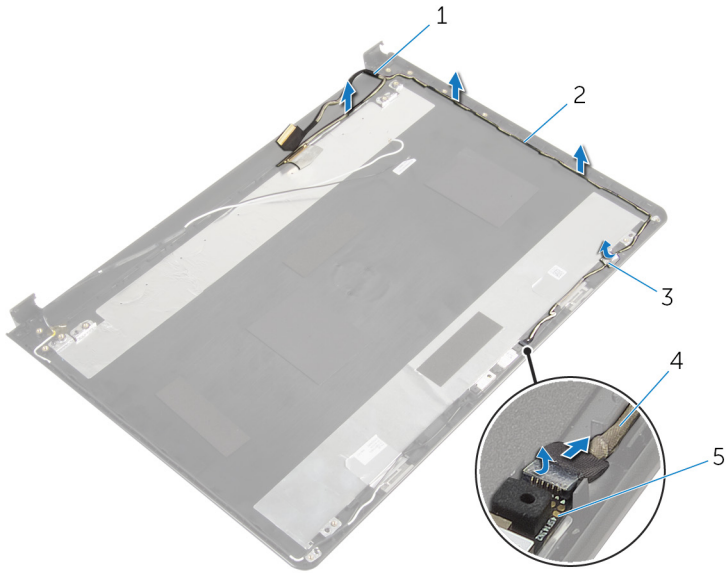

- 1 display cable
- 3 tape
- 5 camera module

- 2 routing guides
- 4 camera cable

Replacing the display cable



WARNING: Before working inside your computer, read the safety information that shipped with your computer and follow the steps in [Before working inside your computer](#). After working inside your computer, follow the instructions in [After working inside your computer](#). For more safety best practices, see the Regulatory Compliance home page at dell.com/regulatory_compliance.

Procedure

- 1 Route the display cable through the routing guides on the display back-cover.
- 2 Route the camera cable through the routing guides on the display back-cover.
- 3 Adhere the tape that secures the camera cable to the display back-cover.
- 4 Connect the camera cable to the connector on the camera module.

Post-requisites

- 1 Replace the [display hinges](#).
- 2 Replace the [display panel](#).
- 3 Replace the [display bezel](#).
- 4 Replace the [display assembly](#).
- 5 Follow the procedure from step 3 to step 8 in "[Replacing the computer base](#)".
- 6 Replace the [keyboard](#).
- 7 Replace the [wireless card](#).
- 8 Replace the [hard drive](#).
- 9 Replace the [base cover](#).
- 10 Replace the [optical drive](#).
- 11 Replace the [battery](#).

Removing the display back-cover and antenna assembly

 **WARNING:** Before working inside your computer, read the safety information that shipped with your computer and follow the steps in [Before working inside your computer](#). After working inside your computer, follow the instructions in [After working inside your computer](#). For more safety best practices, see the Regulatory Compliance home page at dell.com/regulatory_compliance.

Prerequisites

- 1 Remove the [battery](#).
- 2 Remove the [optical drive](#).
- 3 Remove the [base cover](#).
- 4 Remove the [hard drive](#).
- 5 Remove the [wireless card](#).
- 6 Remove the [keyboard](#).
- 7 Follow the procedure from step 1 to step 7 in "[Removing the computer base](#)".
- 8 Remove the [display assembly](#).
- 9 Remove the [display bezel](#).
- 10 Remove the [display panel](#).
- 11 Remove the [display hinges](#).
- 12 Remove the [display cable](#).

Procedure

After performing all the prerequisites, we are left with the display back-cover and antenna assembly.

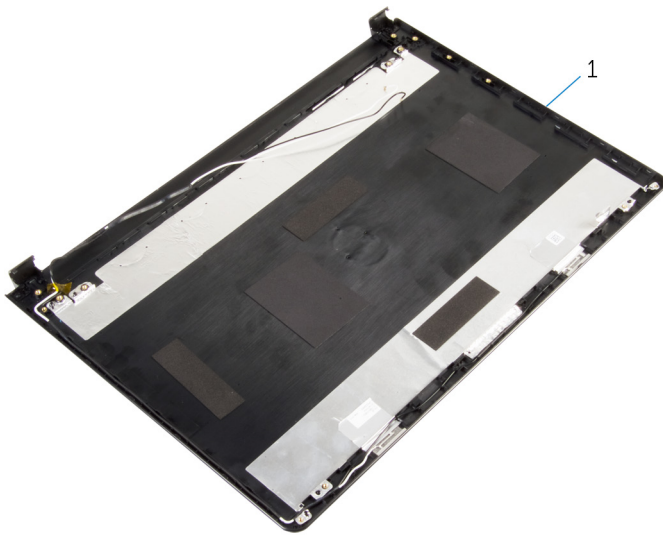

- 1 display back-cover and antenna assembly

Replacing the display back-cover and antenna assembly

 **WARNING:** Before working inside your computer, read the safety information that shipped with your computer and follow the steps in [Before working inside your computer](#). After working inside your computer, follow the instructions in [After working inside your computer](#). For more safety best practices, see the Regulatory Compliance home page at dell.com/regulatory_compliance.

Procedure

Place the display back-cover on a flat surface.

Post-requisites

- 1 Replace the [display cable](#).
- 2 Replace the [display hinges](#).
- 3 Replace the [display panel](#).
- 4 Replace the [display bezel](#).
- 5 Replace the [display assembly](#).
- 6 Follow the procedure from step 3 to step 8 in "[Replacing the computer base](#)".
- 7 Replace the [keyboard](#).
- 8 Replace the [wireless card](#).
- 9 Replace the [hard drive](#).
- 10 Replace the [base cover](#).
- 11 Replace the [optical drive](#).
- 12 Replace the [battery](#).

Removing the camera



WARNING: Before working inside your computer, read the safety information that shipped with your computer and follow the steps in [Before working inside your computer](#). After working inside your computer, follow the instructions in [After working inside your computer](#). For more safety best practices, see the Regulatory Compliance home page at dell.com/regulatory_compliance.

Prerequisites

- 1 Remove the [battery](#).
- 2 Remove the [optical drive](#).
- 3 Remove the [base cover](#).
- 4 Remove the [hard drive](#).
- 5 Remove the [wireless card](#).
- 6 Remove the [keyboard](#).
- 7 Follow the procedure from step 1 to step 7 in "[Removing the computer base](#)".
- 8 Remove the [display assembly](#).
- 9 Remove the [display bezel](#).

Procedure

- 1 Disconnect the camera cable from the camera.
- 2 Using a plastic scribe, gently pry the camera from the display back-cover.

3 Lift the camera off the display back-cover.

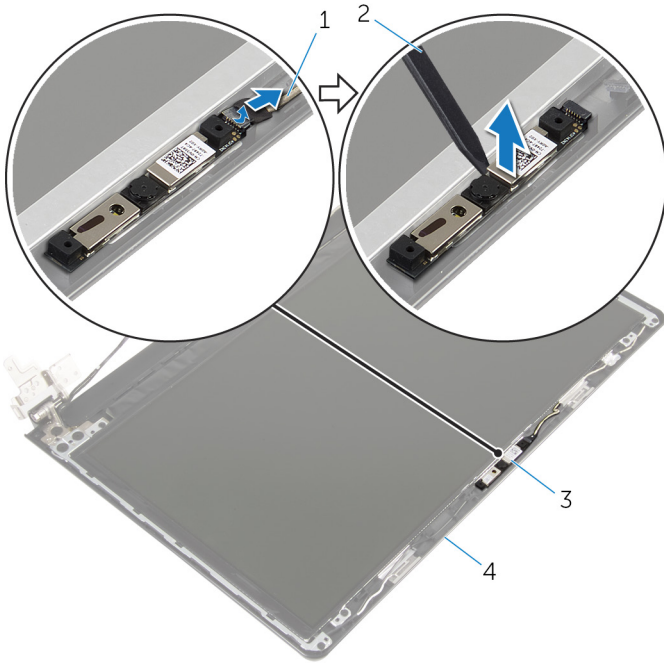

1 camera cable

2 plastic scribe

3 camera

4 display back-cover

Replacing the camera



WARNING: Before working inside your computer, read the safety information that shipped with your computer and follow the steps in [Before working inside your computer](#). After working inside your computer, follow the instructions in [After working inside your computer](#). For more safety best practices, see the Regulatory Compliance home page at dell.com/regulatory_compliance.

Procedure

- 1 Using the alignment post, adhere the camera on the display back-cover.
- 2 Connect the camera cable to the camera connector.

Post-requisites

- 1 Replace the [display bezel](#).
- 2 Replace the [display assembly](#).
- 3 Follow the procedure from step 3 to step 8 in "[Replacing the computer base](#)".
- 4 Replace the [keyboard](#).
- 5 Replace the [wireless card](#).
- 6 Replace the [hard drive](#).
- 7 Replace the [base cover](#).
- 8 Replace the [optical drive](#).
- 9 Replace the [battery](#).

Removing the power-adapter port

 **WARNING:** Before working inside your computer, read the safety information that shipped with your computer and follow the steps in [Before working inside your computer](#). After working inside your computer, follow the instructions in [After working inside your computer](#). For more safety best practices, see the Regulatory Compliance home page at dell.com/regulatory_compliance.

Prerequisites

- 1 Remove the [battery](#).
- 2 Remove the [optical drive](#).
- 3 Remove the [base cover](#).
- 4 Remove the [hard drive](#).
- 5 Remove the [wireless card](#).
- 6 Remove the [keyboard](#).
- 7 Follow the procedure from step 1 to step 7 in "[Removing the computer base](#)".
- 8 Remove the [I/O board](#).
- 9 Remove the [display assembly](#).
- 10 Remove the [system board](#).

Procedure

- 1 Note the power-adapter-port cable routing and remove it from the routing guides on the palm-rest assembly.
- 2 Remove the screw that secures the power-adapter port to the palm-rest assembly.

- 3** Lift the power-adapter port, along with its cable, off the palm-rest assembly.

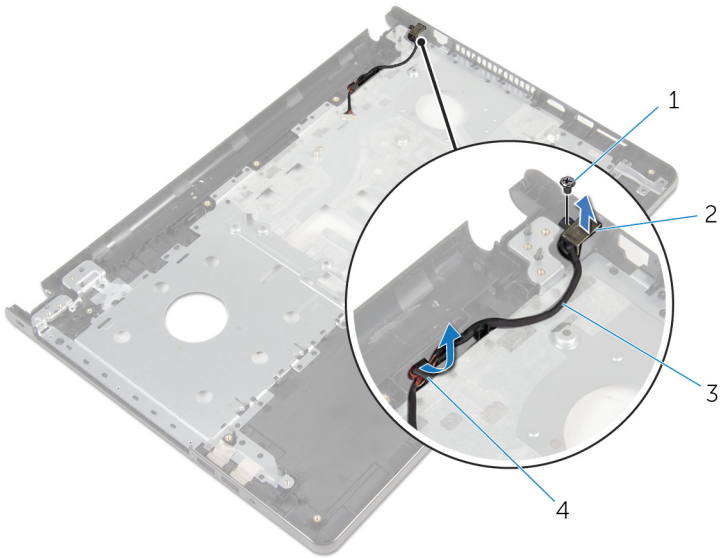

- | | | | |
|---|--------------------------|---|--------------------|
| 1 | screw | 2 | power-adapter port |
| 3 | power-adapter port cable | 4 | routing guides |

Replacing the power-adapter port

 **WARNING:** Before working inside your computer, read the safety information that shipped with your computer and follow the steps in [Before working inside your computer](#). After working inside your computer, follow the instructions in [After working inside your computer](#). For more safety best practices, see the Regulatory Compliance home page at dell.com/regulatory_compliance.

Procedure

- 1 Slide the power-adapter port into position.
- 2 Replace the screw that secures the power-adapter port to the palm-rest assembly.
- 3 Route the power-adapter-port cable through the routing guides on the palm-rest assembly.

Post-requisites

- 1 Replace the [system board](#).
- 2 Replace the [display assembly](#).
- 3 Replace the [I/O board](#).
- 4 Follow the procedure from step 3 to step 8 in "[Replacing the computer base](#)".
- 5 Replace the [keyboard](#).
- 6 Replace the [wireless card](#).
- 7 Replace the [hard drive](#).
- 8 Replace the [base cover](#).
- 9 Replace the [optical drive](#).
- 10 Replace the [battery](#).

Removing the palm-rest assembly



WARNING: Before working inside your computer, read the safety information that shipped with your computer and follow the steps in [Before working inside your computer](#). After working inside your computer, follow the instructions in [After working inside your computer](#). For more safety best practices, see the Regulatory Compliance home page at dell.com/regulatory_compliance.

Prerequisites

- 1 Remove the [battery](#).
- 2 Remove the [optical drive](#).
- 3 Remove the [base cover](#).
- 4 Remove the [hard drive](#).
- 5 Remove the [wireless card](#).
- 6 Remove the [keyboard](#).
- 7 Follow the procedure from step 1 to step 7 in "[Removing the computer base](#)".
- 8 Remove the [I/O board](#).
- 9 Remove the [display assembly](#).
- 10 Remove the [power-button module](#).
- 11 Remove the [system board](#).
- 12 Remove the [power-adaptor port](#).

Procedure

After performing all the prerequisites, we are left with the palm-rest assembly.



1 palm-rest assembly

2 touchpad cable

Replacing the palm-rest assembly



WARNING: Before working inside your computer, read the safety information that shipped with your computer and follow the steps in [Before working inside your computer](#). After working inside your computer, follow the instructions in [After working inside your computer](#). For more safety best practices, see the Regulatory Compliance home page at dell.com/regulatory_compliance.

Procedure



Place the palm-rest assembly on a flat surface.

Post-requisites

- 1 Replace the [power-adapter port](#).
- 2 Replace the [system board](#).
- 3 Replace the [power-button module](#).
- 4 Replace the [display assembly](#).
- 5 Replace the [I/O board](#).
- 6 Follow the procedure from step 3 to step 8 in "[Replacing the computer base](#)".
- 7 Replace the [keyboard](#).
- 8 Replace the [wireless card](#).
- 9 Replace the [hard drive](#).
- 10 Replace the [base cover](#).
- 11 Replace the [optical drive](#).
- 12 Replace the [battery](#).

Flashing the BIOS

You may need to flash (update) the BIOS when an update is available or when you replace the system board. To flash the BIOS:

- 1 Turn on the computer.
- 2 Go to dell.com/support.
- 3 Click **Product Support**, enter the Service Tag of your laptop and click **Submit**.
 -  **NOTE:** If you do not have the Service Tag, use the auto-detect feature or manually browse for your computer model.
- 4 Click **Drivers & downloads**.
- 5 Scroll down the page and select **BIOS** from the **Category** drop-down list.
 -  **NOTE:** In the **Change OS** drop-down list, select the operating system installed on your computer.
- 6 Expand **BIOS** to view the available BIOS files.
- 7 Click **Download File** to download the latest version of the BIOS for your computer.
- 8 Save the file and once the download is complete, navigate to the folder where you saved the BIOS update file.
- 9 Double-click the BIOS update file icon and follow the instructions on the screen.